

HEXFET® Power MOSFET

Application

- High Efficiency Synchronous Rectification in SMPS
- Uninterruptible Power Supply
- High Speed Power Switching
- Hard Switched and High Frequency Circuits

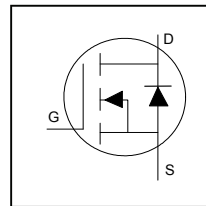

| | |
|--------------------------------|-------------|
| V_{DSS} | 200V |
| R_{DS(on)} typ. | 17mΩ |
| | max |
| I_D | 75A |

Benefits

- Improved Gate, Avalanche and Dynamic dV/dt Ruggedness
- Fully Characterized Capacitance and Avalanche SOA
- Enhanced body diode dV/dt and dI/dt Capability
- Lead-Free, RoHS Compliant

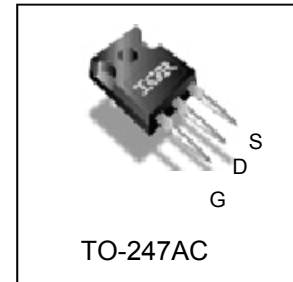

| | | |
|----------|----------|----------|
| G | D | S |
| Gate | Drain | Source |

| Base part number | Package Type | Standard Pack | | Orderable Part Number |
|------------------|--------------|---------------|----------|-----------------------|
| | | Form | Quantity | |
| IRFP4127PbF | TO-247AC | Tube | 25 | IRFP4127PbF |

| | Parameter | Max. | Units |
|---|---|---------------------|-------|
| I _D @ T _C = 25°C | Continuous Drain Current, V _{GS} @ 10V | 75 | A |
| I _D @ T _C = 100°C | Continuous Drain Current, V _{GS} @ 10V | 53 | |
| I _{DM} | Pulsed Drain Current ① | 300 | |
| P _D @ T _C = 25°C | Maximum Power Dissipation | 341 | W |
| | Linear Derating Factor | 2.3 | W/°C |
| V _{GS} | Gate-to-Source Voltage | ± 20 | V |
| dv/dt | Peak Diode Recovery dv/dt③ | 57 | V/ns |
| T _J T _{STG} | Operating Junction and Storage Temperature Range | -55 to + 175 | °C |
| | Soldering Temperature, for 10 seconds (1.6mm from case) | 300 | |
| | Mounting Torque, 6-32 or M3 Screw | 10 lbf·in (1.1 N·m) | |

Avalanche Characteristics

| | | | |
|-------------------------------------|---------------------------------|-----|----|
| E _{AS} (Thermally limited) | Single Pulse Avalanche Energy ② | 244 | mJ |
|-------------------------------------|---------------------------------|-----|----|

Thermal Resistance

| | Parameter | Typ. | Max. | Units |
|------------------|------------------------------------|------|------|-------|
| R _{θJC} | Junction-to-Case ④ | — | 0.4 | °C/W |
| R _{θCS} | Case-to-Sink, Flat Greased Surface | 0.24 | — | |
| R _{θJA} | Junction-to-Ambient ⑦⑧ | — | 40 | |

Static @ T_J = 25°C (unless otherwise specified)

| | Parameter | Min. | Typ. | Max. | Units | Conditions |
|--|--------------------------------------|------|------|------|-------|--|
| V _{(BR)DSS} | Drain-to-Source Breakdown Voltage | 200 | — | — | V | V _{GS} = 0V, I _D = 250μA |
| ΔV _{(BR)DSS} /ΔT _J | Breakdown Voltage Temp. Coefficient | — | 0.23 | — | V/°C | Reference to 25°C, I _D = 5mA |
| R _{DS(on)} | Static Drain-to-Source On-Resistance | — | 17 | 21 | mΩ | V _{GS} = 10V, I _D = 44A ④ |
| V _{GS(th)} | Gate Threshold Voltage | 3.0 | — | 5.0 | V | V _{DS} = V _{GS} , I _D = 250μA |
| I _{DSS} | Drain-to-Source Leakage Current | — | — | 20 | μA | V _{DS} = 200V, V _{GS} = 0V |
| | | — | — | 250 | | V _{DS} = 200V, V _{GS} = 0V, T _J = 125°C |
| I _{GSS} | Gate-to-Source Forward Leakage | — | — | 100 | nA | V _{GS} = 20V |
| | Gate-to-Source Reverse Leakage | — | — | -100 | | V _{GS} = -20V |
| R _G | Gate Resistance | — | 3.0 | — | Ω | |

Dynamic Electrical Characteristics @ T_J = 25°C (unless otherwise specified)

| | | | | | | |
|---------------------------|---|----|------|-----|----|---|
| g _{fs} | Forward Transconductance | 45 | — | — | S | V _{DS} = 50V, I _D = 44A |
| Q _g | Total Gate Charge | — | 100 | 150 | nC | I _D = 44A |
| Q _{gs} | Gate-to-Source Charge | — | 30 | — | | V _{DS} = 100V |
| Q _{gd} | Gate-to-Drain Charge | — | 31 | — | | V _{GS} = 10V |
| Q _{sync} | Total Gate Charge Sync. (Q _g - Q _{gd}) | — | 69 | — | | I _D = 44A, V _{DS} = 0V, V _{GS} = 10V |
| t _{d(on)} | Turn-On Delay Time | — | 17 | — | ns | V _{DD} = 100V |
| t _r | Rise Time | — | 18 | — | | I _D = 44A |
| t _{d(off)} | Turn-Off Delay Time | — | 56 | — | | R _G = 2.7Ω |
| t _f | Fall Time | — | 22 | — | | V _{GS} = 10V |
| C _{iss} | Input Capacitance | — | 5380 | — | pF | V _{GS} = 0V |
| C _{oss} | Output Capacitance | — | 410 | — | | V _{DS} = 50V |
| C _{rss} | Reverse Transfer Capacitance | — | 86 | — | | f = 1.0MHz |
| C _{oss eff.(ER)} | Effective Output Capacitance (Energy Related) | — | 360 | — | | V _{GS} = 0V, V _{DS} = 0V to 160V ^⑥ |
| C _{oss eff.(TR)} | Output Capacitance (Time Related) | — | 590 | — | | See Fig.11 |
| | | | | | | V _{GS} = 0V, V _{DS} = 0V to 160V ^⑤ |

Diode Characteristics

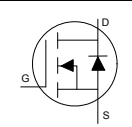
| | Parameter | Min. | Typ. | Max. | Units | Conditions |
|------------------|--|------|------|------|-------|--|
| I _S | Continuous Source Current (Body Diode) ① | — | — | 75 | A | MOSFET symbol showing the integral reverse p-n junction diode.  |
| I _{SM} | Pulsed Source Current (Body Diode) ① | — | — | 300 | | |
| V _{SD} | Diode Forward Voltage | — | — | 1.3 | V | T _J = 25°C, I _S = 44A, V _{GS} = 0V ④ |
| t _{rr} | Reverse Recovery Time | — | 136 | — | ns | T _J = 25°C V _{DD} = 100V |
| | | — | 139 | — | | T _J = 125°C I _F = 44A, |
| Q _{rr} | Reverse Recovery Charge | — | 458 | — | nC | T _J = 25°C di/dt = 100A/μs ④ |
| | | — | 688 | — | | T _J = 125°C |
| I _{RRM} | Reverse Recovery Current | — | 8.3 | — | A | T _J = 25°C |

Notes:

- ① Repetitive rating; pulse width limited by max. junction temperature.
- ② Recommended max EAS limit, starting T_J = 25°C, L = 0.25mH, R_G = 25Ω, I_{AS} = 44A, V_{GS} = 10V.
- ③ I_{SD} ≤ 44A, di/dt ≤ 760A/μs, V_{DD} ≤ V_{(BR)DSS}, T_J ≤ 175°C.
- ④ Pulse width ≤ 400μs; duty cycle ≤ 2%.
- ⑤ C_{oss eff. (TR)} is a fixed capacitance that gives the same charging time as C_{oss} while V_{DS} is rising from 0 to 80% V_{DSS}.
- ⑥ C_{oss eff. (ER)} is a fixed capacitance that gives the same energy as C_{oss} while V_{DS} is rising from 0 to 80% V_{DSS}.
- ⑦ When mounted on 1" square PCB (FR-4 or G-10 Material). For recommended footprint and soldering techniques refer to application note #AN-994
- ⑧ R_θ is measured at T_J approximately 90°C

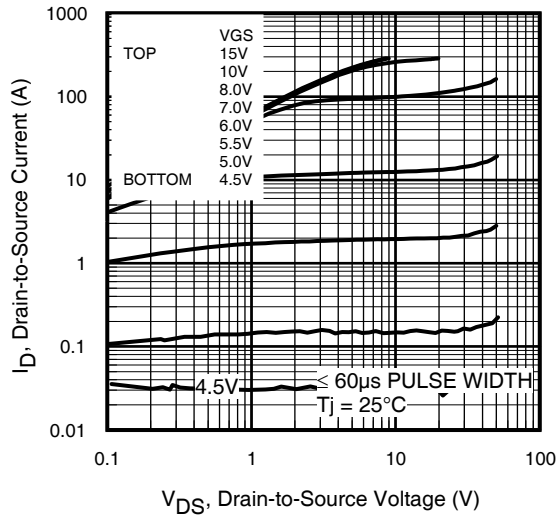
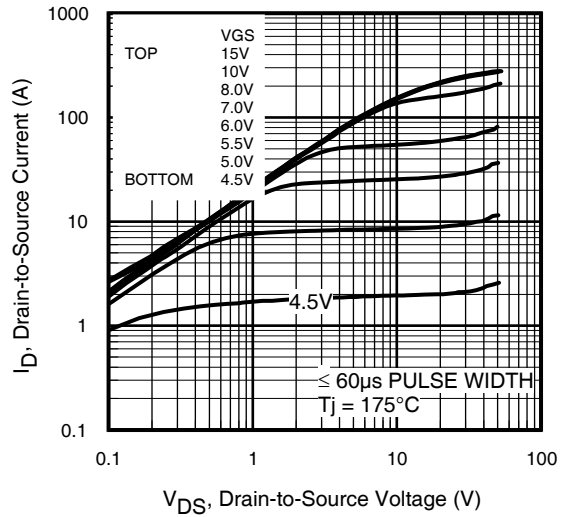
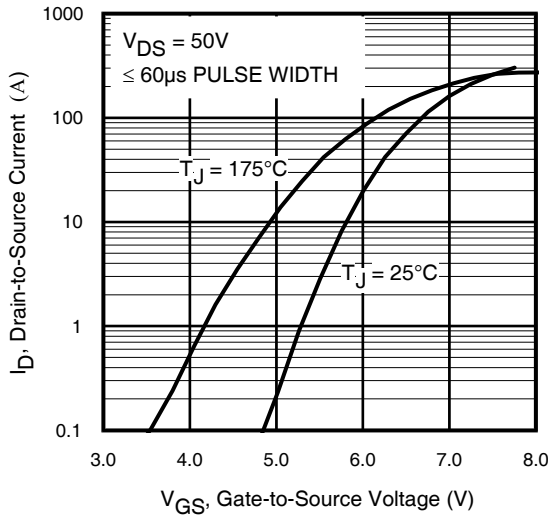
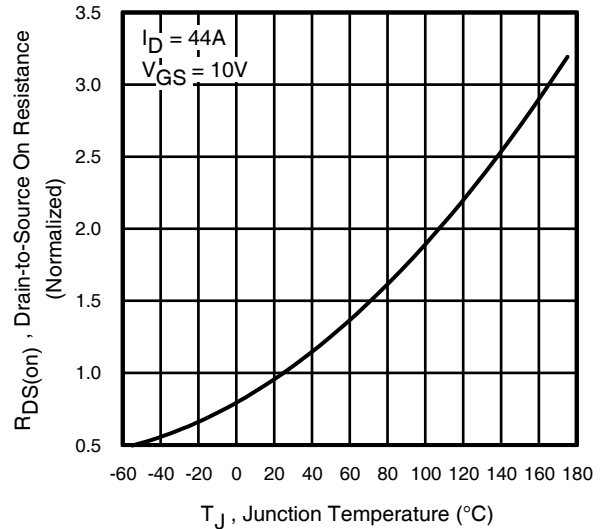
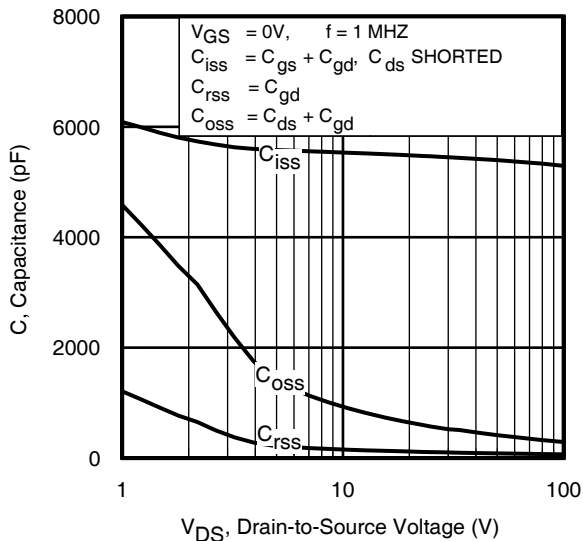
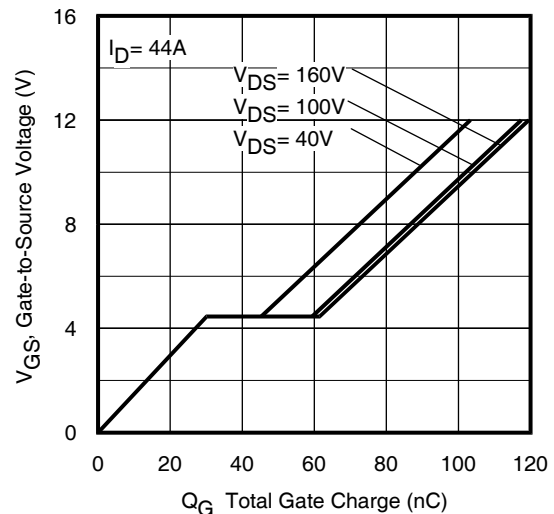
Fig 1. Typical Output Characteristics

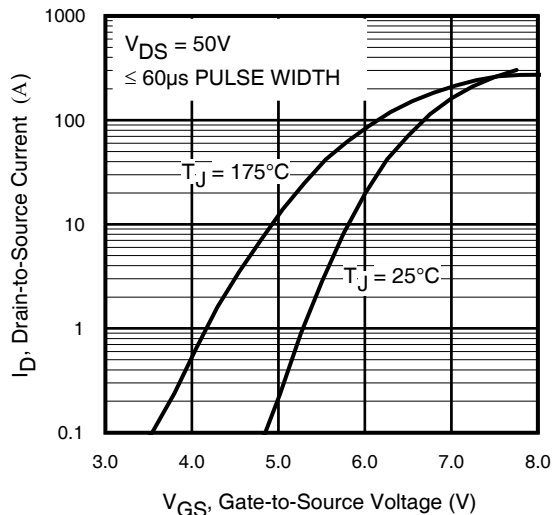
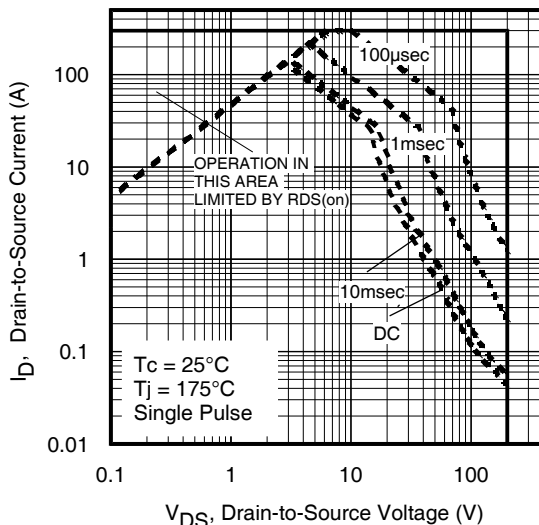
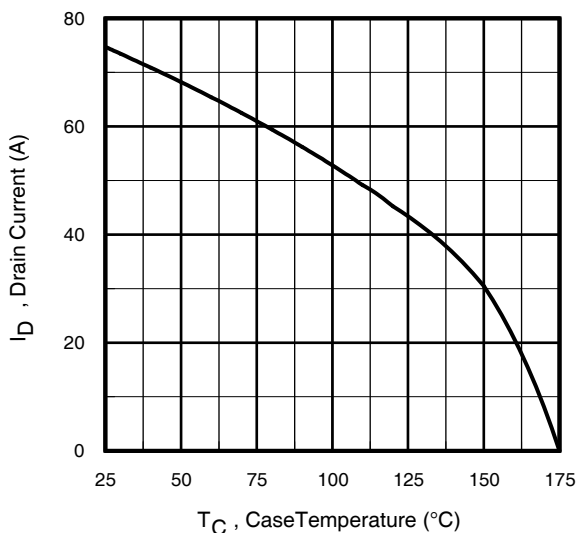
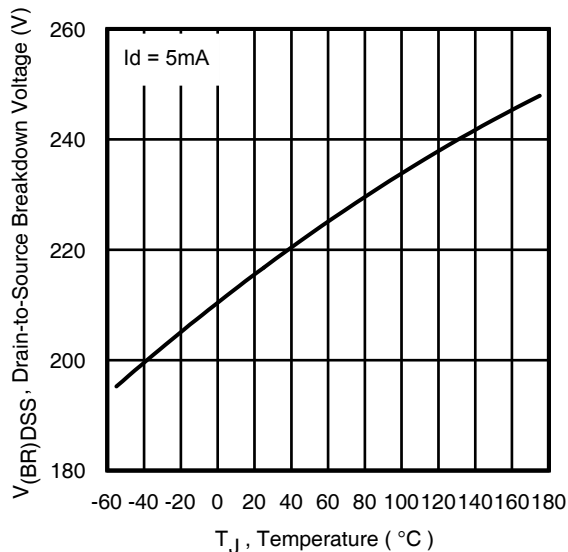
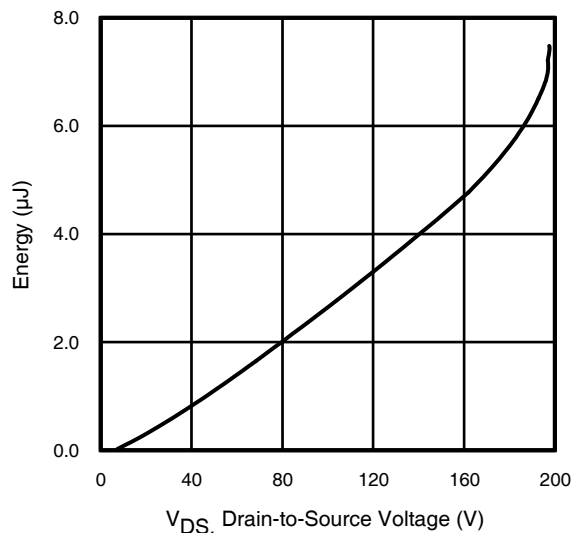
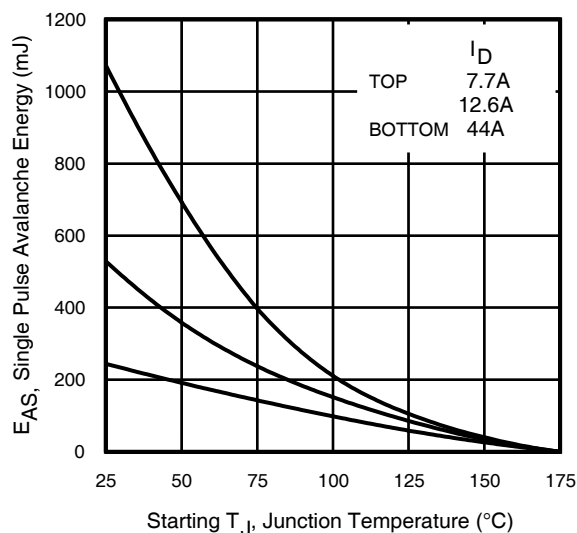
Fig 2. Typical Output Characteristics

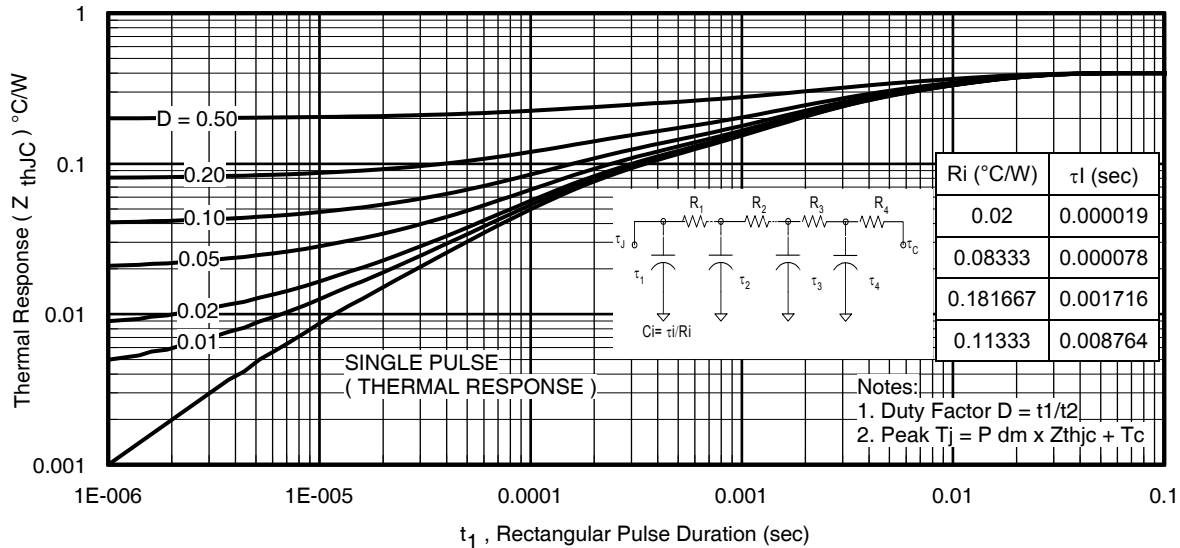
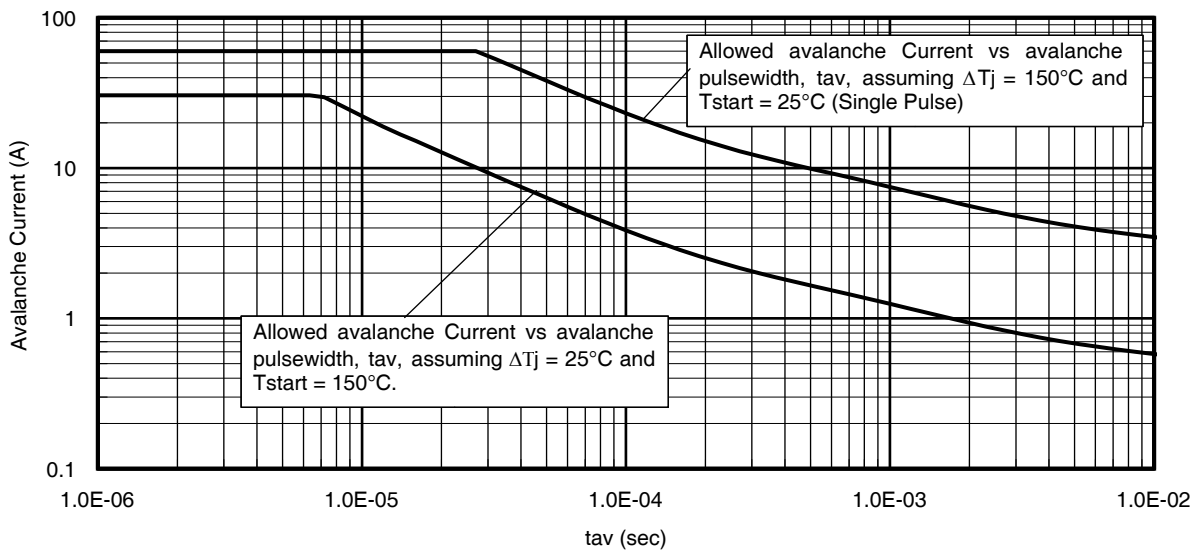
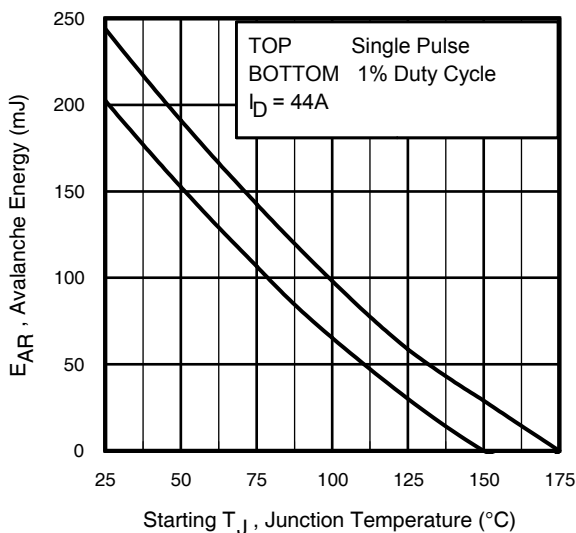
Fig 3. Typical Transfer Characteristics

Fig 4. Normalized On-Resistance vs. Temperature

Fig 5. Typical Capacitance vs. Drain-to-Source Voltage

Fig 6. Typical Gate Charge vs. Gate-to-Source Voltage

Fig 7. Typical Source-Drain Diode Forward Voltage

Fig 8. Maximum Safe Operating Area

Fig 9. Maximum Drain Current vs. Case Temperature

Fig 10. Drain-to-Source Breakdown Voltage

Fig 11. Typical C_{oss} Stored Energy

Fig 12. Maximum Avalanche Energy vs. Drain Current

Fig 13. Maximum Effective Transient Thermal Impedance, Junction-to-Case

Fig 14. Typical Avalanche Current vs. Pulse Width

**Notes on Repetitive Avalanche Curves, Figures 14, 15:
 (For further info, see AN-1005 at www.irf.com)**

1. Avalanche failures assumption:
 Purely a thermal phenomenon and failure occurs at a temperature far in excess of T_{Imax} . This is validated for every part type.
2. Safe operation in Avalanche is allowed as long as T_{Imax} is not exceeded.
3. Equation below based on circuit and waveforms shown in Fig 22a, 22b.
4. $P_{D(ave)}$ = Average power dissipation per single avalanche pulse.
5. BV = Rated breakdown voltage (1.3 factor accounts for voltage increase during avalanche).
6. I_{AV} = Allowable avalanche current.
7. ΔT = Allowable rise in junction temperature, not to exceed T_{Imax} (assumed as 25°C in Fig 14, 15).
 t_{AV} = Average time in avalanche.
 D = Duty cycle in avalanche = $t_{AV} \cdot f$
 $Z_{thJC}(D, t_{AV})$ = Transient thermal resistance, see Fig 13.

$$P_{D(ave)} = 1/2 (1.3 \cdot BV \cdot I_{AV}) \cdot \Delta T / Z_{thJC}$$

$$I_{AV} = 2\Delta T / [1.3 \cdot BV \cdot Z_{thJC}]$$

$$E_{AS(AV)} = P_{D(ave)} \cdot t_{AV}$$

Fig 15. Maximum Avalanche Energy vs. Temperature

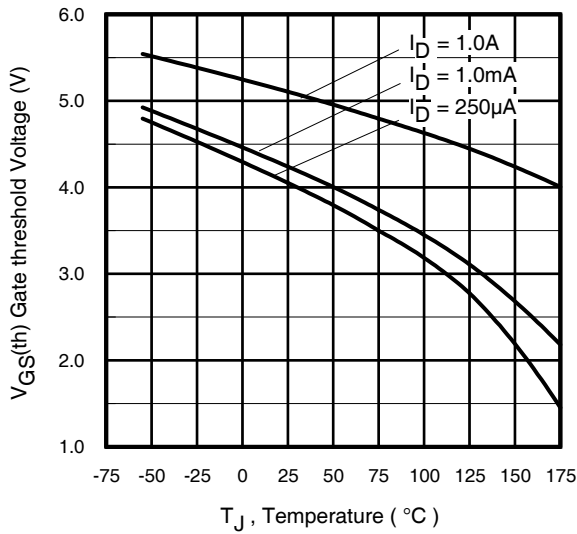
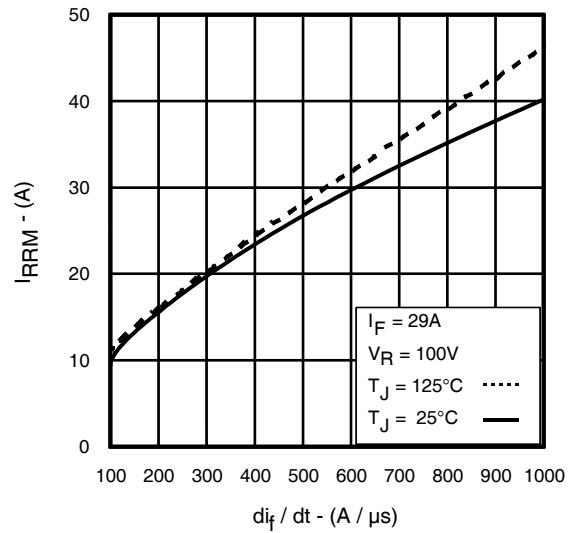
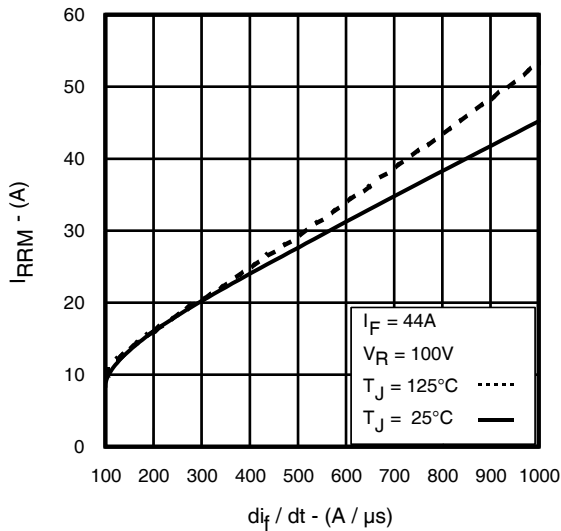
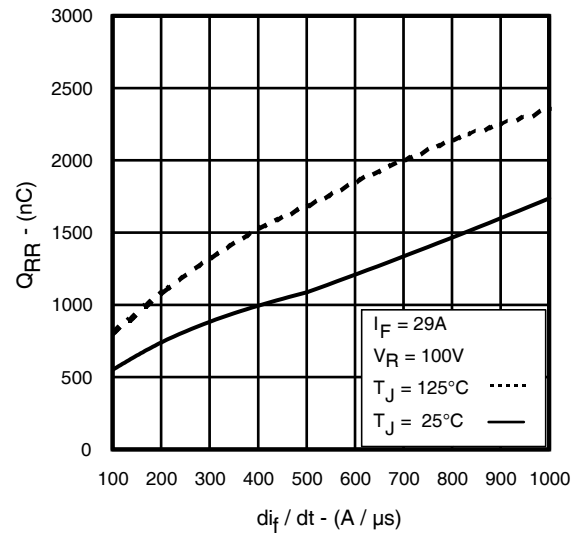
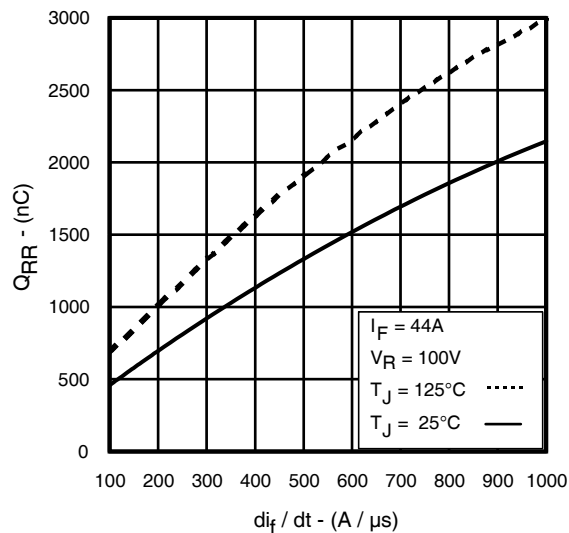
Fig 16. Threshold Voltage vs. Temperature

Fig 17. Typical Recovery Current vs. dif/dt

Fig 18. Typical Recovery Current vs. dif/dt

Fig 19. Typical Stored Charge vs. dif/dt

Fig 20. Typical Stored Charge vs. dif/dt

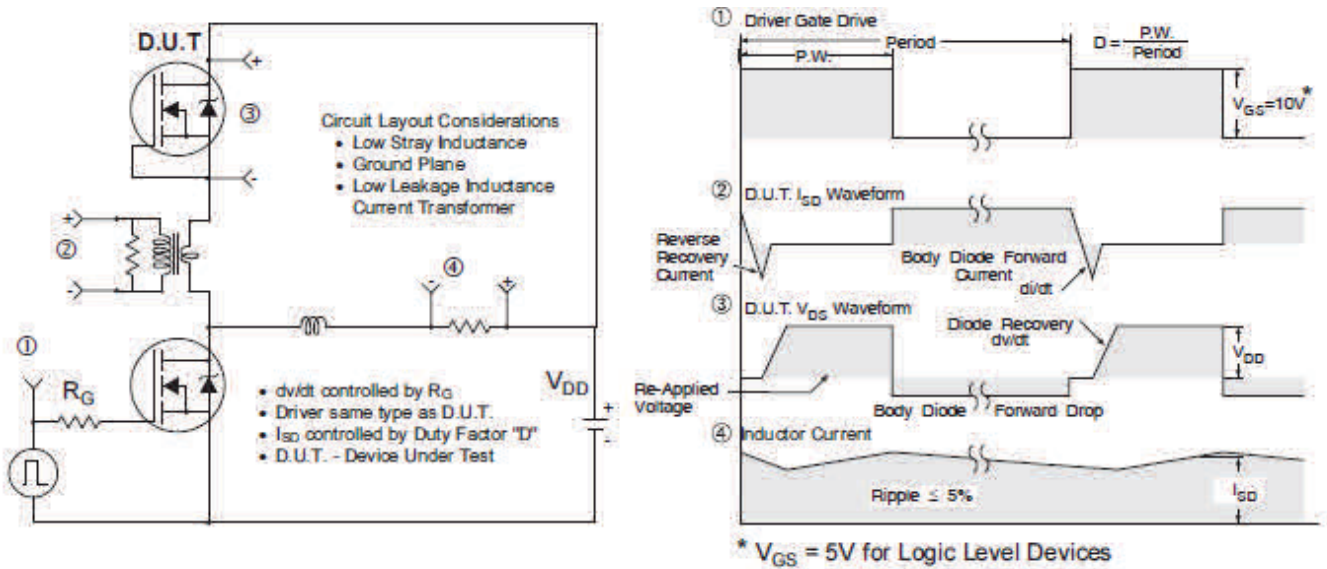

Fig 21. Peak Diode Recovery dv/dt Test Circuit for N-Channel HEXFET® Power MOSFETs

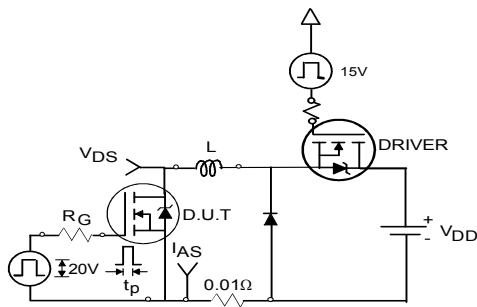

Fig 22a. Unclamped Inductive Test Circuit

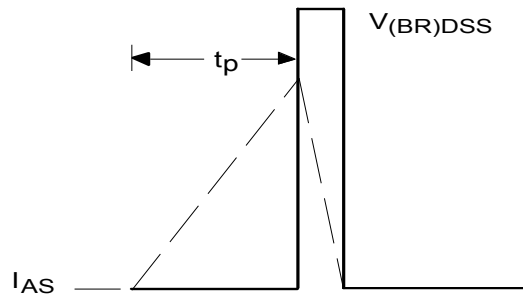

Fig 22b. Unclamped Inductive Waveforms

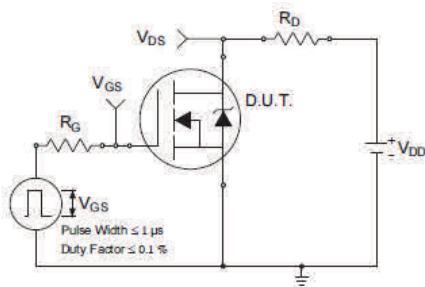

Fig 23a. Switching Time Test Circuit

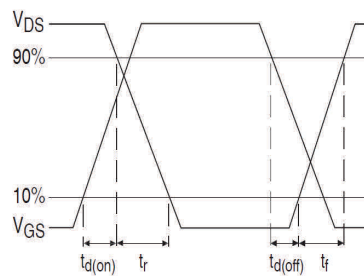

Fig 23b. Switching Time Waveforms

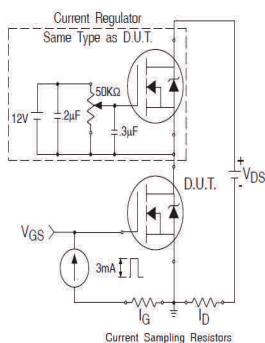

Fig 24a. Gate Charge Test Circuit

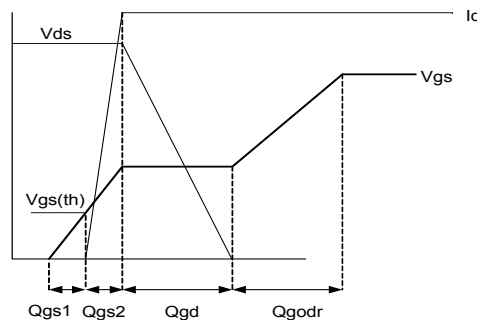
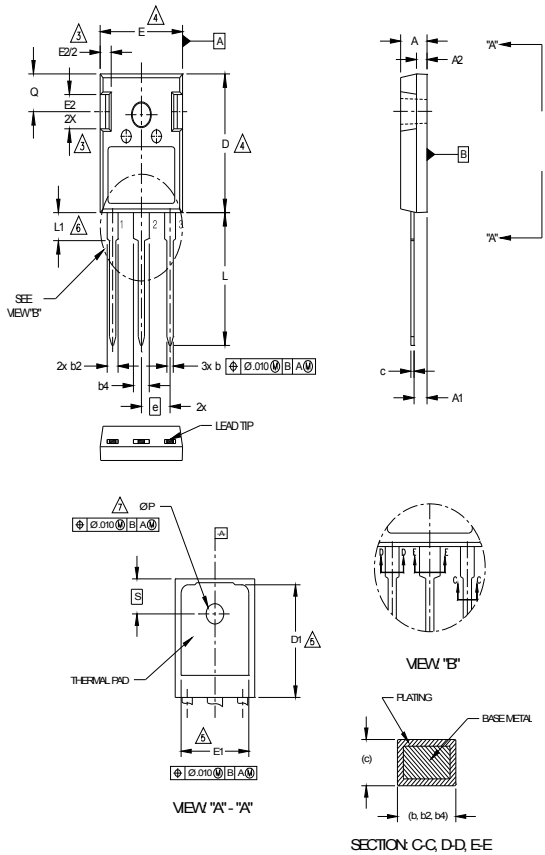

Fig 24b. Gate Charge Waveform

TO-247AC Package Outline

Dimensions are shown in millimeters (inches)



| SYMBOL | DIMENSIONS | | | | NOTES |
|--------|--------------|------|--------------|-------|-------------|
| | INCHES | | MILLIMETERS | | |
| | MIN. | MAX. | MIN. | MAX. | |
| A | .190 | .204 | 4.83 | 5.20 | 4 5 4 |
| A1 | .090 | .100 | 2.29 | 2.54 | |
| A2 | .075 | .085 | 1.91 | 2.16 | |
| b | .042 | .052 | 1.07 | 1.33 | |
| b2 | .075 | .094 | 1.91 | 2.41 | |
| b4 | .113 | .133 | 2.87 | 3.38 | |
| c | .022 | .026 | 0.55 | 0.68 | |
| D | .819 | .830 | 20.80 | 21.10 | |
| D1 | .640 | .694 | 16.25 | 17.65 | |
| E | .620 | .635 | 15.75 | 16.13 | |
| E1 | .512 | .570 | 13.00 | 14.50 | |
| E2 | .145 | .196 | 3.68 | 5.00 | |
| e | .215 Typical | | 5.45 Typical | | |
| L | .780 | .800 | 19.80 | 20.32 | |
| L1 | .161 | .173 | 4.10 | 4.40 | |
| ø P | .138 | .143 | 3.51 | 3.65 | |
| Q | .216 | .236 | 5.49 | 6.00 | |
| S | .238 | .248 | 6.04 | 6.30 | |

LEAD ASSIGNMENTS
HEXFET

- 1.- GATE
- 2.- DRAIN
- 3.- SOURCE
- 4.- DRAIN

IGBTs, CoPACK

- 1.- GATE
- 2.- COLLECTOR
- 3.- EMITTER
- 4.- COLLECTOR

DIODES

- 1.- ANODE/OPEN
- 2.- CATHODE
- 3.- ANODE

NOTES:

- 1 DIMENSIONING AND TOLERANCING AS PER ASME Y14.5M 1994.
- 2 DIMENSIONS ARE SHOWN IN INCHES AND MILLIMETERS.
- 3 CONTOUR OF SLOT OPTIONAL.
- 4 DIMENSION D & E DO NOT INCLUDE MOLD FLASH. MOLD FLASH SHALL NOT EXCEED .005" (0.127) PER SIDE. THESE DIMENSIONS ARE MEASURED AT THE OUTERMOST EXTREMES OF THE PLASTIC BODY.
- 5 THERMAL PAD CONTOUR OPTIONAL WITHIN DIMENSIONS D1 & E1.
- 6 LEAD FINISH UNCONTROLLED IN L1.
- 7 ø P TO HAVE A MAXIMUM DRAFT ANGLE OF 1.5° TO THE TOP OF THE PART WITH A MAXIMUM HOLE DIAMETER OF .154 INCH.

TO-247AC Part Marking Information

Notes: This part marking information applies to devices produced after 02/26/2001

EXAMPLE: THIS IS AN IRFPE30
WITH ASSEMBLY
LOT CODE 5657
ASSEMBLED ON WW 35, 2001
IN THE ASSEMBLY LINE "H"

Note: "P" in assembly line position
indicates "Lead-Free"

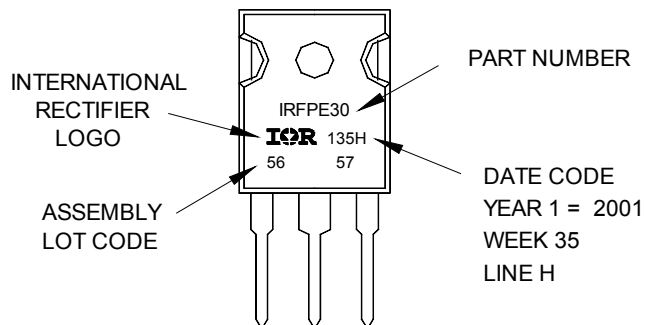

TO-247AC package is not recommended for Surface Mount Application.

Note: For the most current drawing please refer to IR website at <http://www.irf.com/package/>

Qualification Information[†]

| | | |
|-----------------------------------|---|-----|
| Qualification Level | Industrial (per JEDEC JESD47F) ^{††} | |
| Moisture Sensitivity Level | TO-247AC | N/A |
| RoHS Compliant | Yes | |

† Qualification standards can be found at International Rectifier's web site: <http://www.irf.com/product-info/reliability/>

†† Applicable version of JEDEC standard at the time of product release.

Data and specifications subject to change without notice.

International
 Rectifier

IR WORLD HEADQUARTERS: 101N Sepulveda., El Segundo, California 90245, USA Tel: (310) 252-7105

TAC Fax: (310) 252-7903

Visit us at www.irf.com for sales contact information.

IMPORTANT NOTICE

The information given in this document shall in no event be regarded as a guarantee of conditions or characteristics ("Beschaffheitsgarantie").

With respect to any examples, hints or any typical values stated herein and/or any information regarding the application of the product, Infineon Technologies hereby disclaims any and all warranties and liabilities of any kind, including without limitation warranties of non-infringement of intellectual property rights of any third party.

In addition, any information given in this document is subject to customer's compliance with its obligations stated in this document and any applicable legal requirements, norms and standards concerning customer's products and any use of the product of Infineon Technologies in customer's applications.

The data contained in this document is exclusively intended for technically trained staff. It is the responsibility of customer's technical departments to evaluate the suitability of the product for the intended application and the completeness of the product information given in this document with respect to such application.

For further information on the product, technology, delivery terms and conditions and prices please contact your nearest Infineon Technologies office (www.infineon.com).

WARNINGS

Due to technical requirements products may contain dangerous substances. For information on the types in question please contact your nearest Infineon Technologies office.

Except as otherwise explicitly approved by Infineon Technologies in a written document signed by authorized representatives of Infineon Technologies, Infineon Technologies' products may not be used in any applications where a failure of the product or any consequences of the use thereof can reasonably be expected to result in personal injury.

Mouser Electronics

Authorized Distributor

Click to View Pricing, Inventory, Delivery & Lifecycle Information:

[Infineon:](#)

[IRFP4127PBF](#)